

B - 1904mm
H - 641mm
T - 450mm

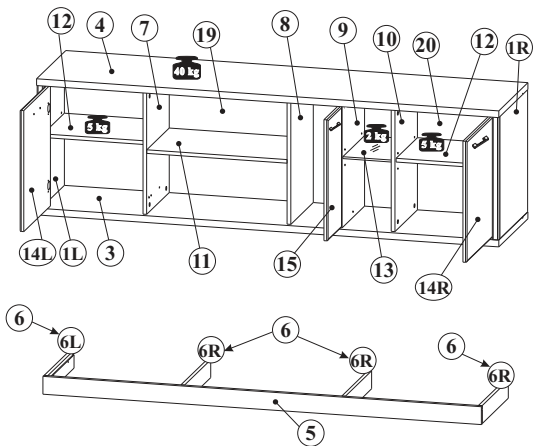

1L+1R	606	448	2	1/2
3	1902	450	1	2/2
4	1902	450	1	2/2
5	1812	74	1	2/2
6	405	74	4	2/2
7	506	348	1	1/2
8	506	348	1	1/2
9	506	348	1	1/2
10	506	348	1	1/2
11	580	347	1	1/2
12	418	330	2	1/2
13	200	335	1	1/2
14L+14R	410	500	2	1/2
15	203	500	1	1/2
16a	592	308	1	1/2
16b	573	220	1	1/2
17L+17R	302	140	2	1/2
17	538	140	1	1/2
18	549	300	1	1/2
19	1024	615	1	2/2
20	648	615	1	2/2

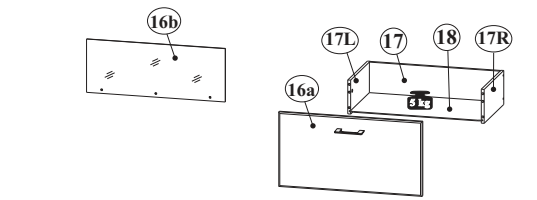
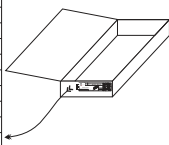
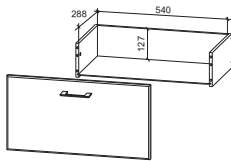

<p>NR 1</p> <p>B1 ϕ 8x28 x28</p> <p>M1 ϕ15x12mm x28</p> <p>T1 5x39mm x28</p> <p>J23 x16</p> <p>P2 3x20 x6</p> <p>G4 L-4,5 ϕ 7 x3</p> <p>F16 4x16 x3</p>	<p>NR 2</p> <p>Y1 ϕ35 Kr15 x4</p> <p>D6 H2 x6</p> <p>E30 6,3 x 24 x8</p> <p>S8 4x13 x12</p> <p>DS6 x4</p> <p>Y2 ϕ35 Kr8 x2</p> <p>E3 6,3x13 x4</p>	<p>NR 3</p> <p>Q30 L-300mm x1L/1R</p> <p>E24 6,0x11 x4</p> <p>P5 4x30 x4</p> <p>M2 ϕ12x10mm x4</p> <p>T2 5x35mm x4</p> <p>S4 3x16 x2</p> <p>S3 3,5x13 x4</p>	<p>NR 4</p> <p>F33 x13</p> <p>P13 3,5x13 x68</p> <p>F12 x4</p>	<p>NR 5</p> <p>C14 ϕ20mm x12</p> <p>C142 ϕ20mm x4</p> <p>F15 x12</p> <p>W13 x4</p> <p>W1 x8</p>	<p>NR 6</p> <p>U196 x4</p> <p>P4 4x25 x8</p>	<p>NR 7</p> <p>O20 x1</p> <p>O21 MAX 6 W x1</p> <p>NR 8</p> <p>J11 x2</p>
--	---	--	---	--	---	---

C 1/2



<p>PL Produkt je zaměřený prodlužit svazky, které se vstříkují do speciální vlnitosti na předřizujícího toporozměry (UEF) 2019/2015</p>	<p>DE Diese Produkt enthält Lichtquellen, die aufgrund ihrer Eigenschaften nicht unter die Verordnung (EU) 2019/2015 fallen</p>	<p>CS Tento výrobek obsahuje světelné zdroje, které vzhledem ke svým vlastnostem nepodléhají do oblasti působnosti nařízení (EU) 2019/2015</p>
<p>DA Disse produkt indeholder lyskilder, som på grund af deres egenskaber er uden for anvendelsesområdet for forordningen (EU) 2019/2015</p>	<p>EL Αυτό το προϊόν περιλαμβάνει πηγές φωτός οι οποίες, λόγω των ιδιοτήτων τους, δεν καλύπτονται από τη νέα ρύθμιση της Ευρωπαϊκής Ένωσης (ΕΕ) 2019/2015</p>	<p>EW These products contain light sources which, due to their properties, are out of the scope of Regulation (EU) 2019/2015</p>
<p>ES Estos productos contienen fuentes de luz que, por sus propiedades, quedan fuera del ámbito de aplicación del Reglamento (UE) 2019/2015.</p>	<p>ET Need tootet sisalduvad valgusallikad, mis on oma omaduste tõttu väljaspool Euroopa Liidu reguleerimisalast välja</p>	<p>FI Näinä tuotteet sisältävät valonlähteitä, jotka ominaisuuksiensa vuoksi eivät kuulu sovelletun (EU) 2019/2015 soveltamisalan</p>
<p>FR Ces produits contiennent des sources lumineuses qui, en raison de leurs propriétés, n'entrent pas dans le champ d'application du règlement (UE) 2019/2015</p>	<p>HU Ezek a terméknek olyan fényforrások tartalmazzak, amelyek tulajdonságuk miatt nem tartoznak az (EU) 2019/2015 rendelet hatálya alá</p>	<p>IT Questi prodotti contengono sorgenti luminose che, per le loro proprietà, esulano dal campo di applicazione del Regolamento (UE) 2019/2015</p>
<p>LT Šiuose gamtiniuose yra šviesos šaltiniai, kurie dėl savo savybių nepatenka į Reglamentą (EU) 2019/2015 taikymo sritį</p>	<p>LV Šie produkti satur gaismas avotus, kas to īpašību dēļ ir ārpus Regulas (ES) 2019/2015 darbības jomas</p>	<p>RU Эти продукты содержат источники света, которые не в scope действия на подпадают под действие Регламента (ЕС) 2019/2015.</p>
<p>PT Estes produtos contêm fontes de luz que, devido às suas propriedades, estão fora do âmbito do Regulamento (UE) 2019/2015</p>	<p>RO Acesta produse conțin surse de lumină care, datorită proprietăților lor, nu sînt în domeniul de aplicare al Regulamentului (UE) 2019/2015</p>	<p>NL Deze producten bevatten lichtbronnen die vanwege hun eigenschappen buiten het toepassingsgebied van Verordening (EU) 2019/2015 vallen</p>
<p>SK Tento výrobek obsahuje světelné zdroje, které vzhledem ke svým vlastnostem nepodléhají do oblasti působnosti nařízení (EU) 2019/2015</p>	<p>SL Ti izdelki vsebujejo svetlobne vire, ki zaradi svojih lastnosti ne spadajo na področje uporabe Uredbe (EU) 2019/2015</p>	<p>SV Dessa produkt innehåller ljuskällor som på grund av sina egenskaper inte omfattas av förordningen (EU) 2019/2015</p>
<p>TR Bu ürünler, özellikleri nedeniyle bu tür ışık kaynaklarına veya cihazlarına dâhil değildir. (EU) 2019/2015</p>	<p>HR Ovi proizvodi sadrže izvorne svjetlosti koji zbog svojih osobina nisu obuhvaćeni Uredbom (EU) 2019/2015</p>	<p>BG Тези продукти съдържат източници на светлина, които поради своите свойства не са обхванати на Регламента (ЕС) 2019/2015</p>

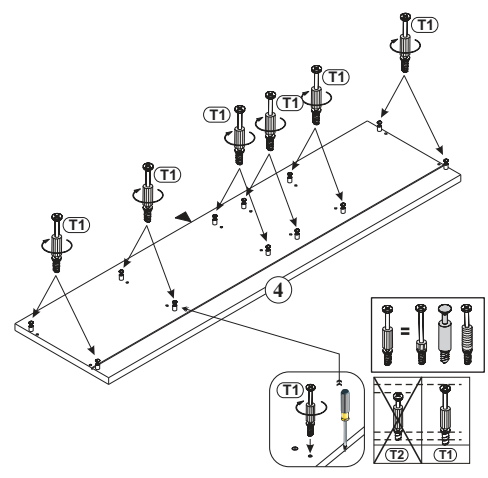
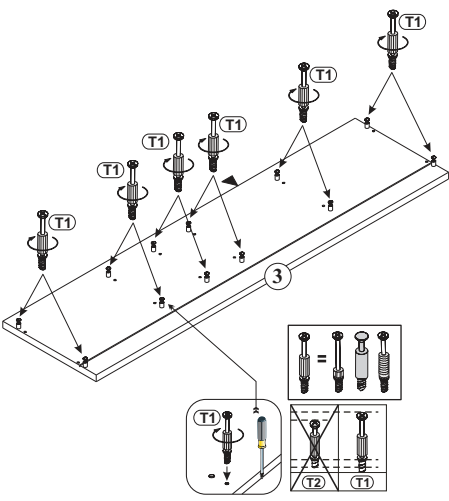

3

- (B1)** ϕ 8x28 x8
- (DS6)** x4
- (E30)** 6.3 x 24 x8

- (M1)** ϕ 15x12mm x8
- (D6)** H2 x4

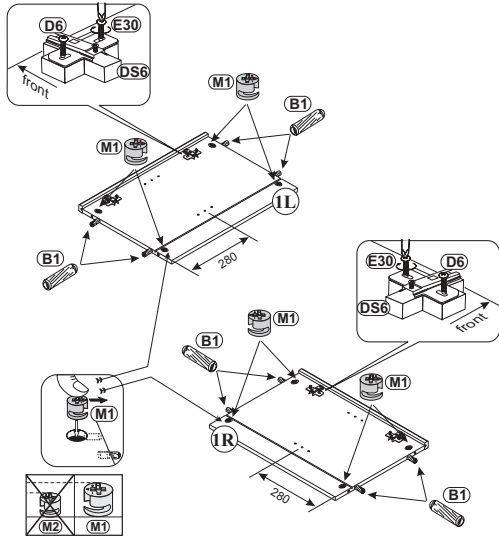

4

- (B1)** ϕ 8x28 x8

- (M1)** ϕ 15x12mm x8

- (T1)** 5x39mm x4

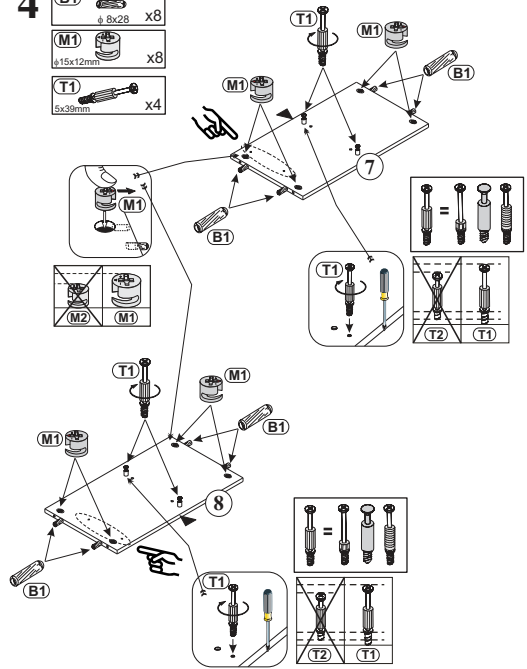

5

- (B1)** ϕ 8x28 x4
- (D6)** H2 x2

- (M1)** ϕ 15x12mm x4
- (E3)** 6.3x13 x4

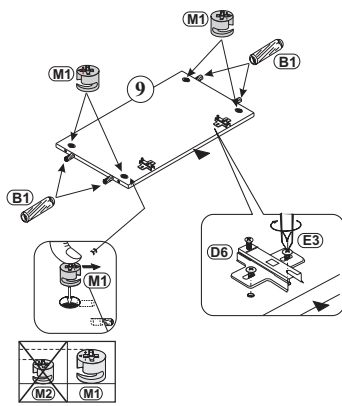

6

- (B1)** ϕ 8x28 x8

- (M1)** ϕ 15x12mm x8

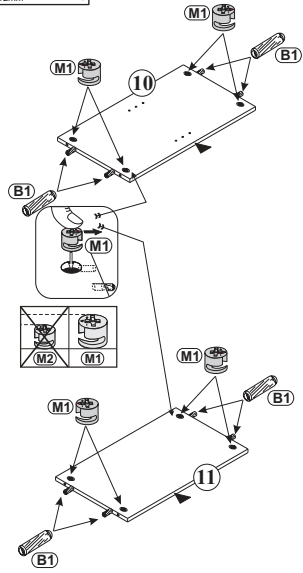

7

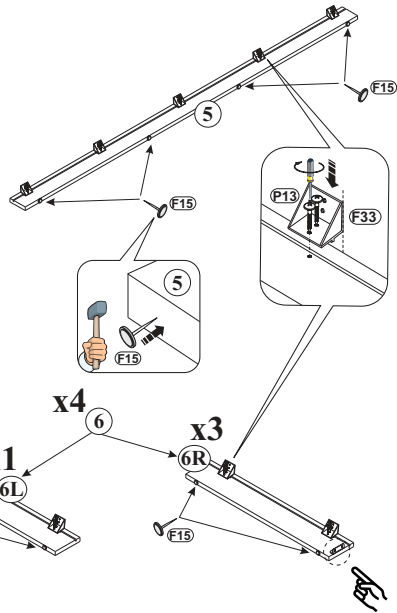
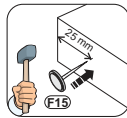
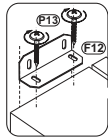
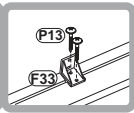
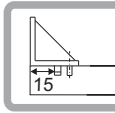
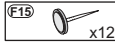
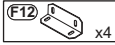

8

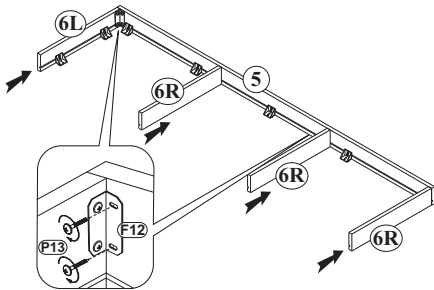

9

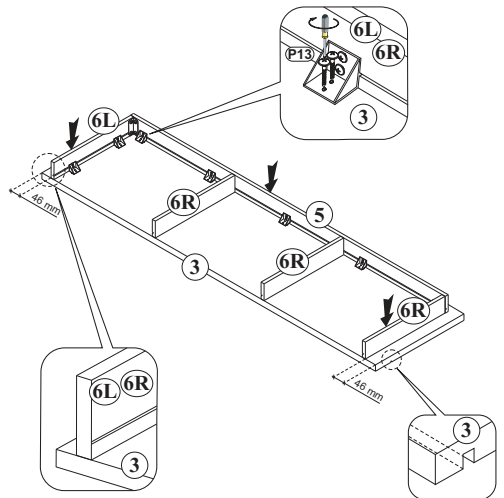

10

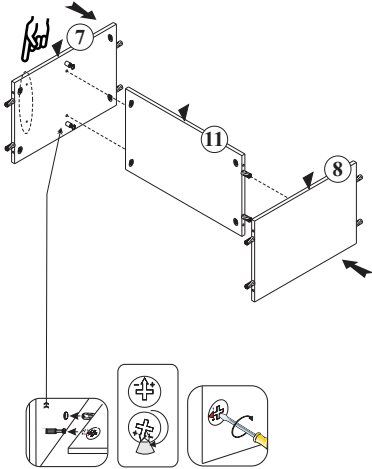

11

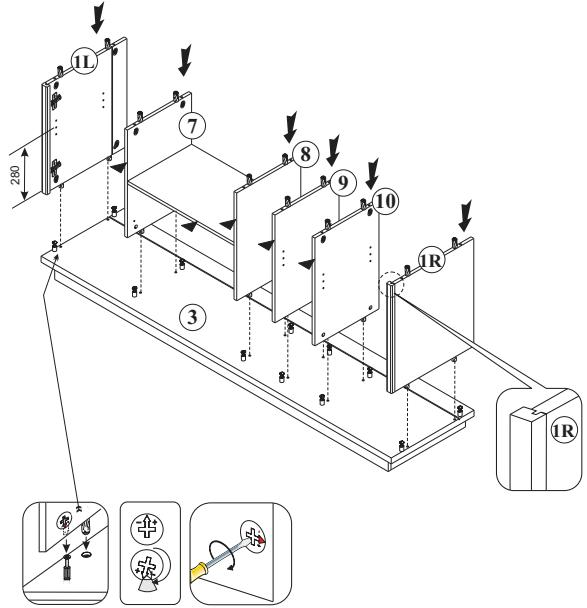

12

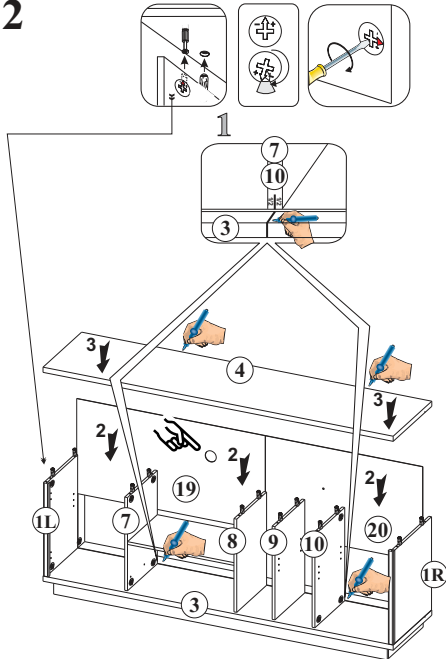

13

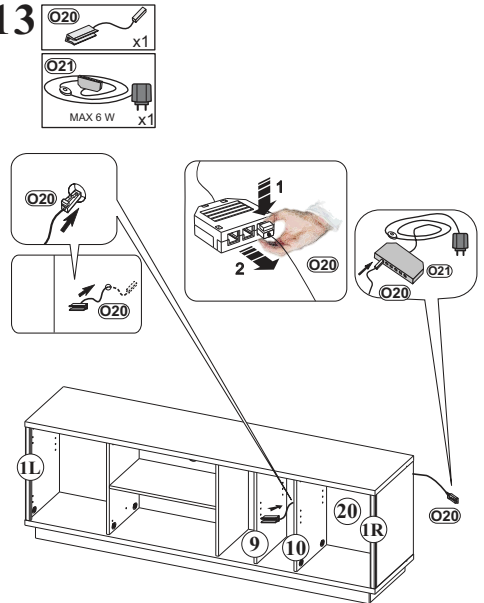

14

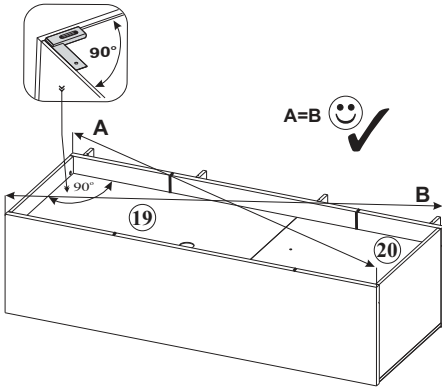

15

- J23 x14
- P2 3x20 x6

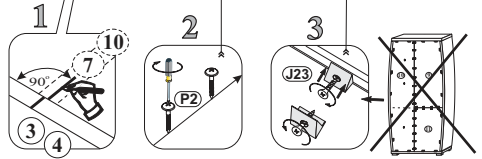
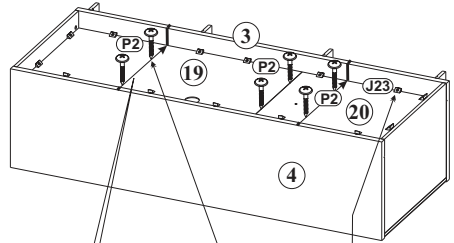

16

- W13 x4
- W1 x8

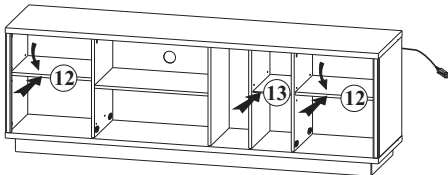
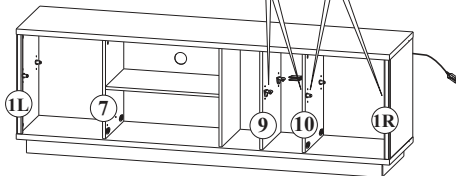
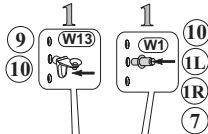

17

- Q30 x1L/1R
- E24 6.0x11 x4
- S3 3.5x13 x4

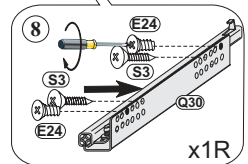
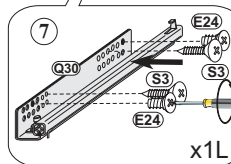
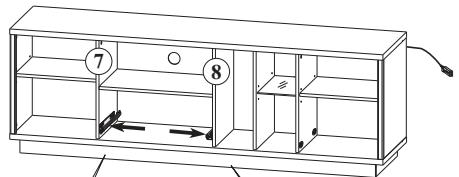

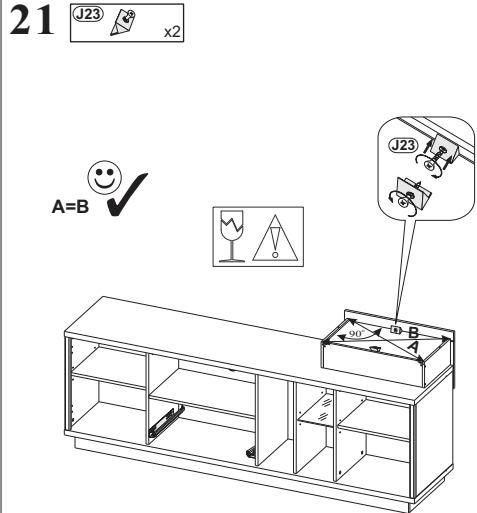
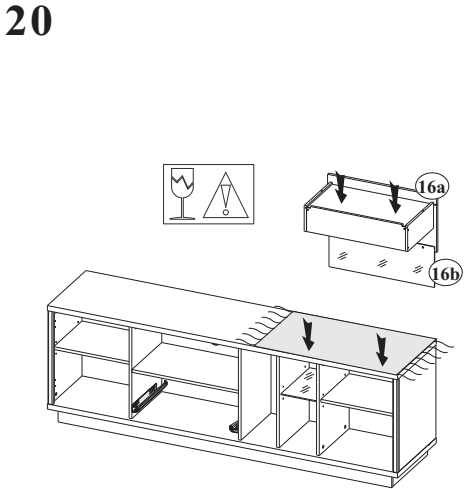
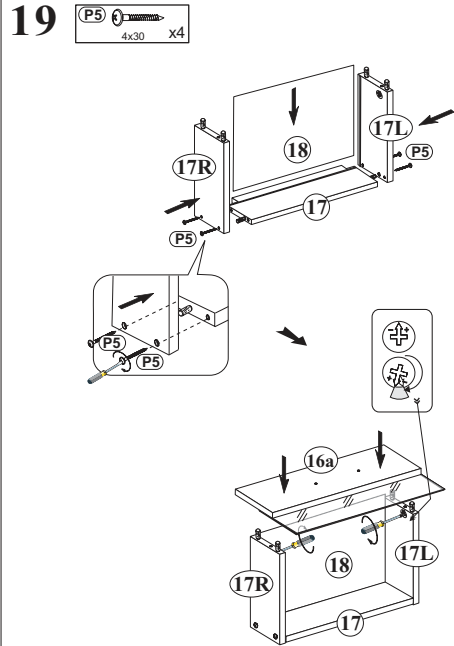
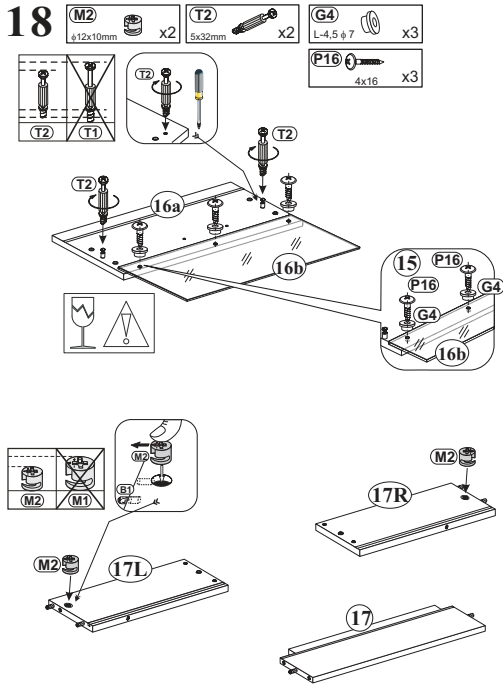

22

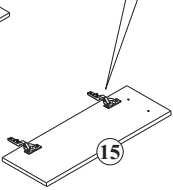
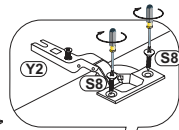
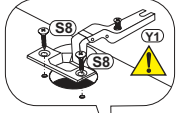
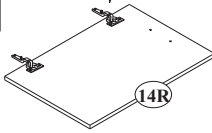
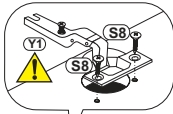
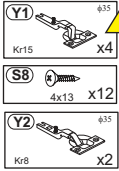

23

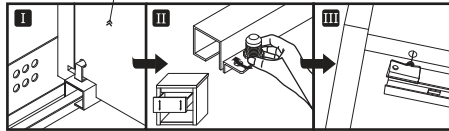
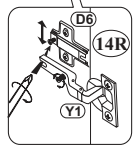
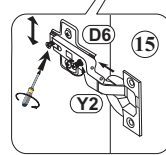
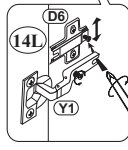
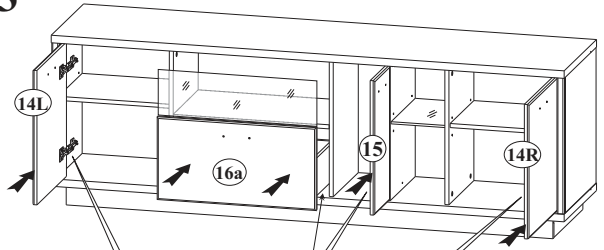

24

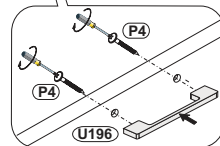
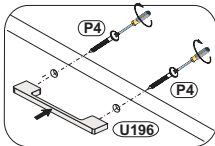
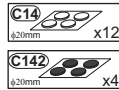

25

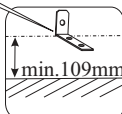
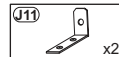
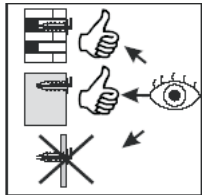

1500mm

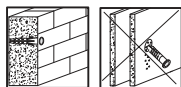
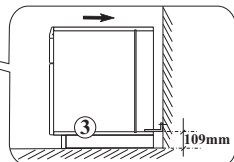
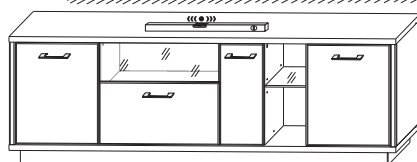

26

